

Electric Multipliers Operating Instructions

Rev 1.0

The manual is a guide for operating the following Electric Multiplier models: Eliminator-EF, Eliminator-EF Plus, Eliminator-EFW, Eliminator-EFW Plus and Eliminator-EFR



Eliminator-EF



Eliminator-EF Plus

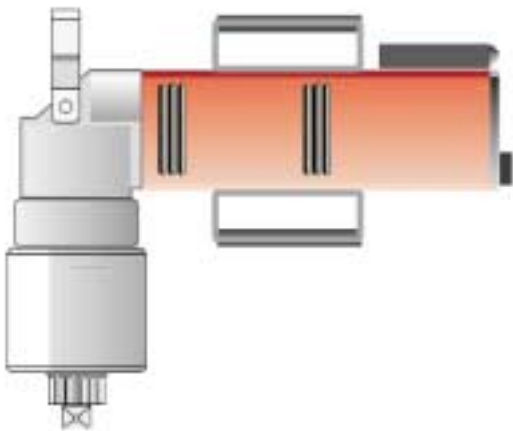

**Eliminator-EFW
Eliminator-EFW Plus**

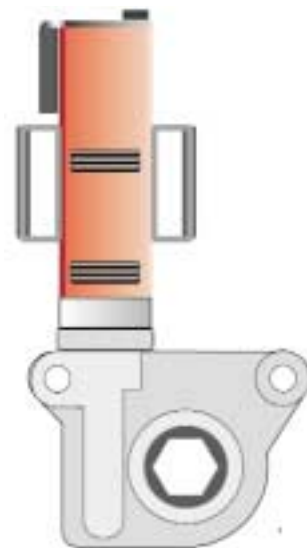

Eliminator-EFR

Electric Multipliers Operating Instructions

Rev 1.0

General Description of the Electric Multipliers

Operation via an electric & frequency controlled brush-free synchronized motor. The models feature a high mounting speed and reduce shut-off speed when reaching final torque. The units are suitable for all international electric networks.



Eliminator-EF

In-line tool. CW/CCW direction. Features a LED display - light emitting diode displays pre-set torque within 19 stages as well as adjusted torque direction.

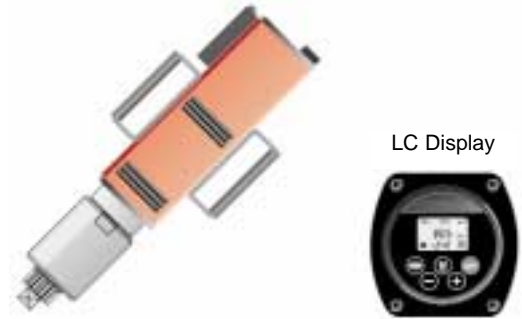

Eliminator-EF Plus

In-line tool. CW/CCW direction. Features a LC display - the pre-set torque and angle rotation can be programmed on an illuminated display.



Eliminator-EFW & Eliminator-EFW Plus

Right Angle tool. CW/CCW direction. **Eliminator EFW:** Features a LED display - light emitting diode displays pre-set torque within 19 stages as well as adjusted torque direction. **Eliminator EFW Plus:** Features a LC display - the pre-set torque and angle rotation can be programmed on an illuminated display.

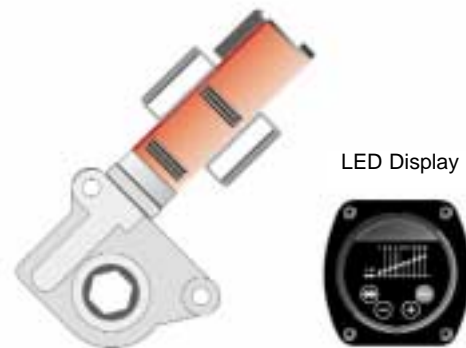

Eliminator-EFR

Low profile radial head allows access where clearance is limited like heat exchanger plate applications. CW/CCW direction. Features a LED display - light emitting diode displays pre-set torque within 19 stages as well as adjusted torque direction.

Electric Multipliers Operating Instructions

Rev 1.0

Safety

1. The electric multiplier should not be operated or serviced unless the operator has read the Operation Manual and fully understands it.

2. The electric multiplier is designed for continuously tightening and loosening of heavy-duty bolt & fastening applications. It is not suited for operations with mixing or drilling machines. This can damage the tool and/or injure the operator. External mechanical forces - like the use as a crowbar - must not be exerted on the equipment (risk of deformation). For other applications not mentioned herein please consult the manufacturer. No other voltages than those specified in this manual (see Technical data) must be used.

Operation



Please observe local laws and regulations when using the tool. The electric multiplier is not for use in explosive environments or in the presence of combustible materials (gas, varnish, fertilizer, gas stations etc.). Compare motor nameplate against power availability to prevent motor burnout or dangerous electrical overloading. Make sure that the plugs and cords are secure before operating. When using the tools outdoors be sure to use the properly gauged exterior power cord.



The electric multipliers must not be used in wet areas. Depending on the working area and how the tool is used, local health and safety regulations may require you to wear protective gear (e.g. safety shoes, protective glasses, protective helmet etc.). In case external forces are exerted on the equipment non-compliance with these regulations may result in major injuries (e.g. electric shocks, bruises, head injuries due to moving parts). You should wear ear protection when placing the tool into operation.



If the Electric Multipliers are going to be used in rain or/and damp conditions, we recommend you to purchase the Electric Multipliers with Protection Class "IP 54". For further information contact customer service.



Electric Multipliers Operating Instructions

Rev 1.0

Placing Tool into Service



Prepare the electric multiplier for fastening application, before you connect the plug. Double check that the standard sockets or any adapter are correctly fitted and undamaged. Never use damaged parts under any circumstances.



To tighten or loosen hard or soft joints, specific torque ups or adapters are needed in accordance with a specific fastening application (available as accessories). Standard sockets or adapters are placed on the square drive and secured.

Preparation for Fastening

- Place Electric Multiplier on flat surface
- Insert reaction device onto spline (8)
- Place standard socket onto square drive (7)

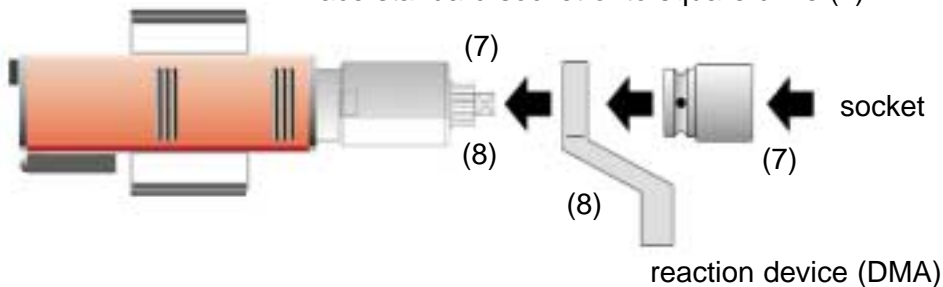

Preparation for Fastening(details)

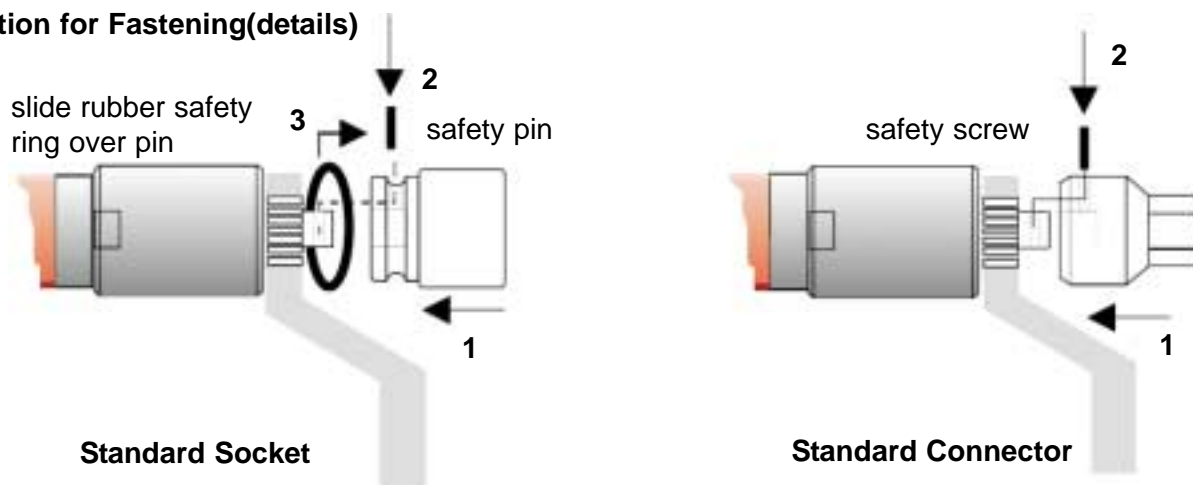

Maintenance



We recommend you send the electric multiplier for recalibration after approximately 25 operational hours. Please note that accuracy of the tool is +/- 5% when used at the correct operating temperature, corresponding voltage (100-253 V / 45-66Hz) and nominal sensitivity (2 kw).

If you suspect that electric multiplier is losing power or recognize any damage, the tool requires service and should be sent back.

Electric Multipliers Operating Instructions

Rev 1.0

Operation of Eliminator-EF & Eliminator-EFW

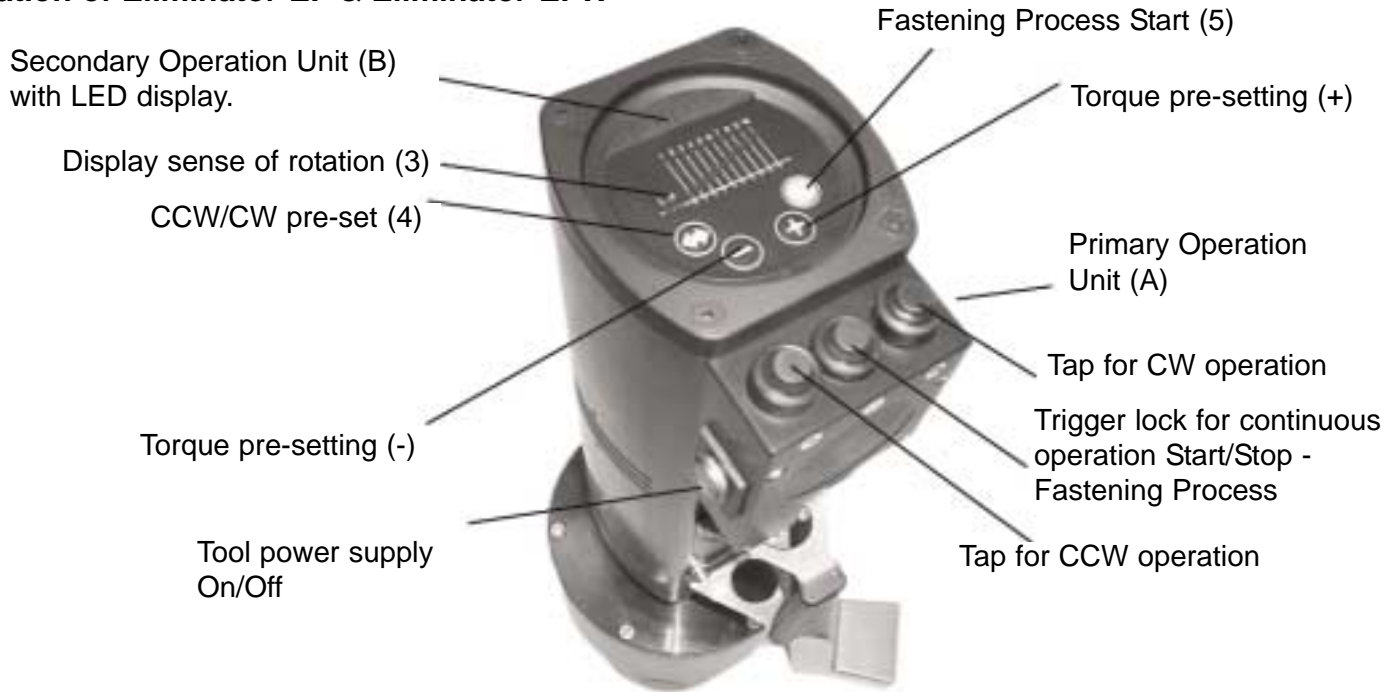

Primary Operation Unit (A)

1. Switching tool On/Off of tool, i.e. connection/separation with/from power supply.
2. Operation of tool during Mounting/Dismounting
 - Tap for CW operation (tool stops when releasing the button).
 - Tap for CCW operation (tool stops when releasing the button).
 - Tool Start (when pressing the button the tool changes to trigger lock for continuous operation) and when reaching pre-set torque tools shuts off precisely.
 - Tool stops when pressing the button again



Before starting trigger lock for continuous operation

The electronic of the tool stores rotation which has been carried out last e.g. key for CW-direction is activated - sense of rotation is automatically pre-set to right direction when starting trigger lock for continuous operation etc.. Corresponding LED (3) is flashing in Secondary Operation Unit (B) and displays sense of rotation. If you would like to change sense of rotation press key CW/CCW pre-set (4) or briefly press corresponding key (tap for CW/CCW operation) The start trigger lock for continuous operation.

3. Pressing any button during trigger lock for continuous operation - the fastening process stops.

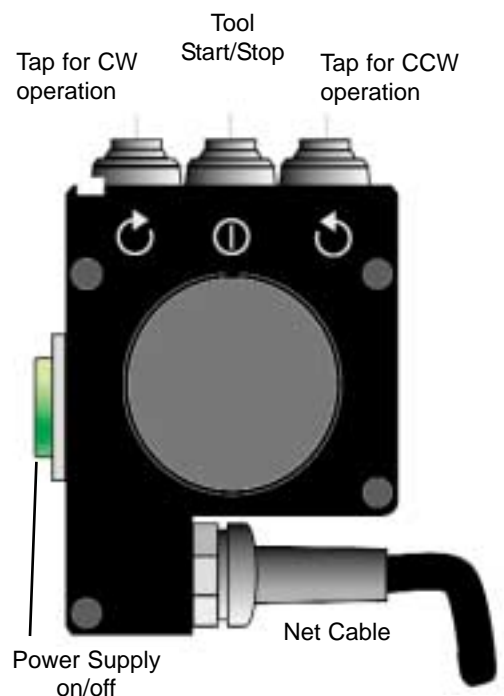

Electric Multipliers Operating Instructions

Rev 1.0

Secondary Operation Unit (B)

1. Pre-setting of desired torque limit-value via keys (+/-)
Steps 1-10 (one LED is flashing) and 9 intermediate steps (two LEDs are flashing) are selected. The figures 1-10 correspond to the Nm values according to the torque chart. Intermediate values are to be taken from the flow chart.
2. Display of sense of rotation (3) and torque preset (changeover button 4)
3. Trigger lock for continuous operation starts (start button 5)



While mounting or dismounting we recommend to use the Primary Operation Unit.

Operation of Eliminator-EF Plus & Eliminator-EFW Plus

Standard Program (Modes)

Mode	Description
M 1	Tightening with torque Option: automatic loosening according to pre-settable angle degrees*
M 2	Tightening with pre-torque and finishing-angle tortion. Option: automatic loosening according to pre-settable angle degrees*

Mode	Important Operational Steps
M 1	Enter sense of rotation, nominal torque, Enter released angle
M 2	Enter sense of rotation, pre-set torque, and finishing-angle tortion Enter released angle

Secondary Operation Unit (EF Plus & EFW Plus)

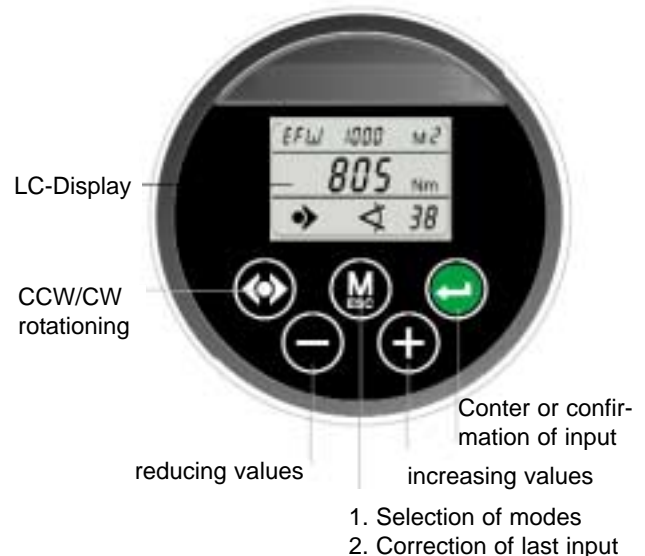

* **Attention:** Releasing only serves to “run free” the DMA (reaction device) not loosening the screw or nut.

Selection of mode by pressing



Important:
Each operational step has to be confirmed by pressing:



Cancellation of last input by pressing:



Escape - function

Values or functional symbols are flashing continuously until confirmation is carried out

Electric Multipliers Operating Instructions

Rev 1.0

Adjustment of Programs (Modes) for Eliminator-EF Plus & Eliminator-EFW Plus

Adjustment Mode 1

Tightening with torque. Option: Automatic release

Step 1

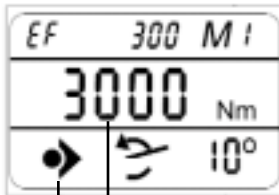
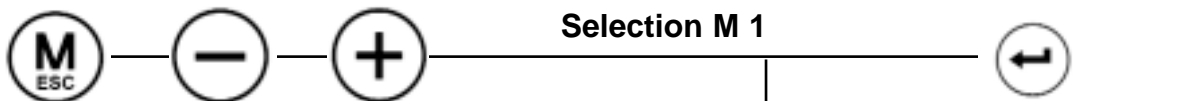

Step 2



Step 3

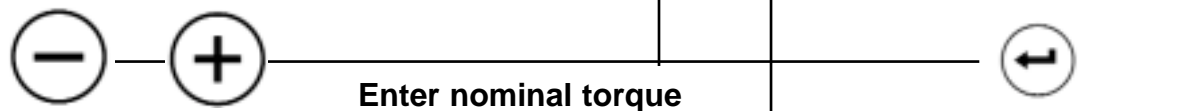

Step 4



No automatic release:
Set angle to zero

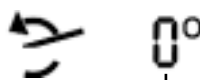

Tool ready to start

Electric Multipliers Operating Instructions

Rev 1.0

Adjustment Mode 2

Tightening with pre-set torque and finishing-angle tortion. Option: automatic release

Step 1

Confirm input

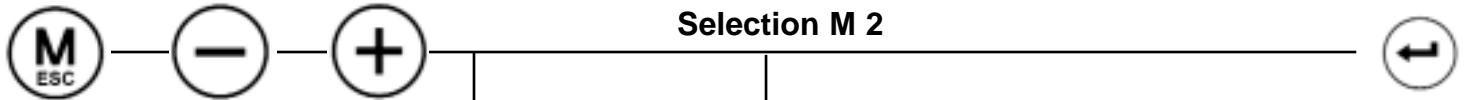

Selection M 2



Step 2

Confirm input

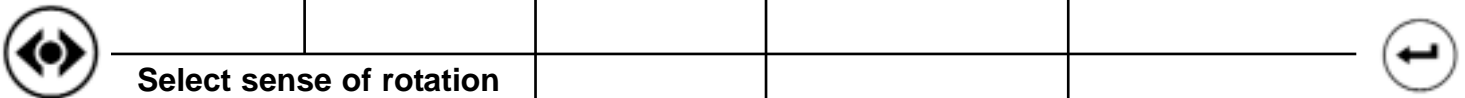

Select sense of rotation

Step 3

Confirm input

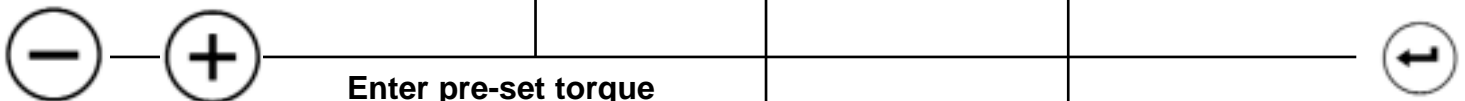

Enter pre-set torque

Step 4

Confirm input

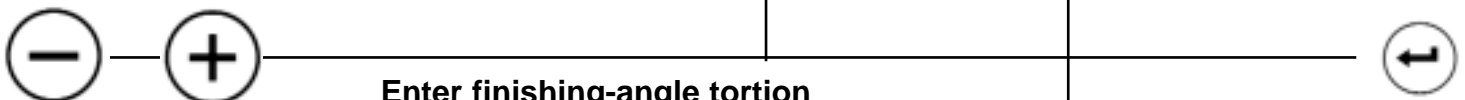

Enter finishing-angle tortion

Step 5

Confirm input

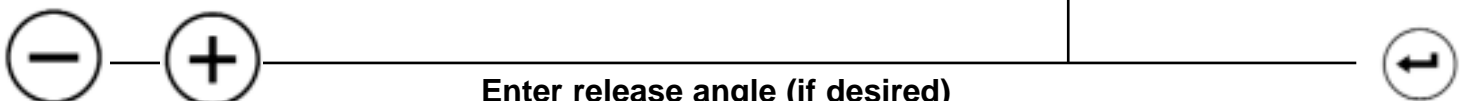

Enter release angle (if desired)

No automatic release:
Set angle to zero

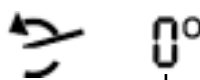

IM Adjustment Mode

Electric Multipliers Operating Instructions

Rev 1.0

(Optional) Adjustment Mode 3

Tightening with pre-set torque angle degrees

Step 1

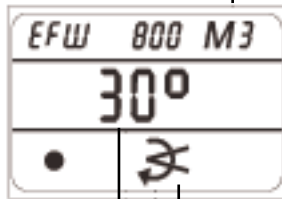
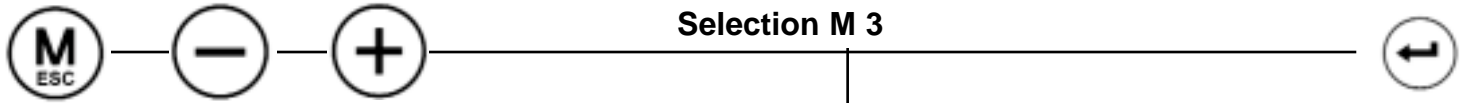

Step 2



Step 3



Tool Ready to Start

Note: Tightening with max. torque - low speed

Electric Multipliers Operating Instructions

Rev 1.0

(Optional) Adjustment Mode 4

Tightening with pre-set rotations

Step 1

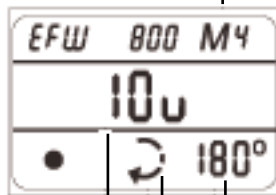
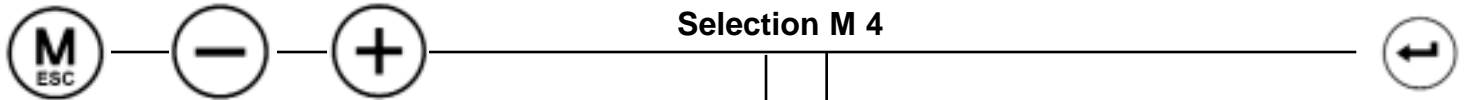

Example shows
10 1/2 rotations.

Step 2

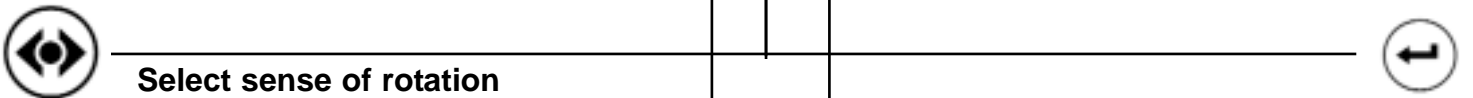

Step 3

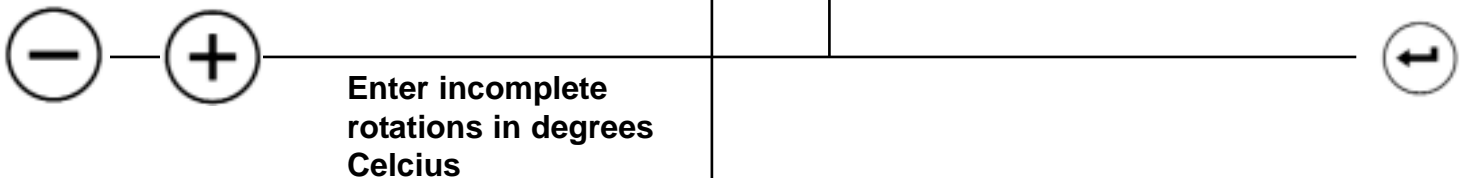

Step 4



Tool Ready to Start

Display of rotation during operation:

Generally rotations are counted counter "0", which means always the remaining rotations are being displayed. When operation is interrupted remaining rotations are also displayed.

Electric Multipliers Operating Instructions

Rev 1.0

LC - Display

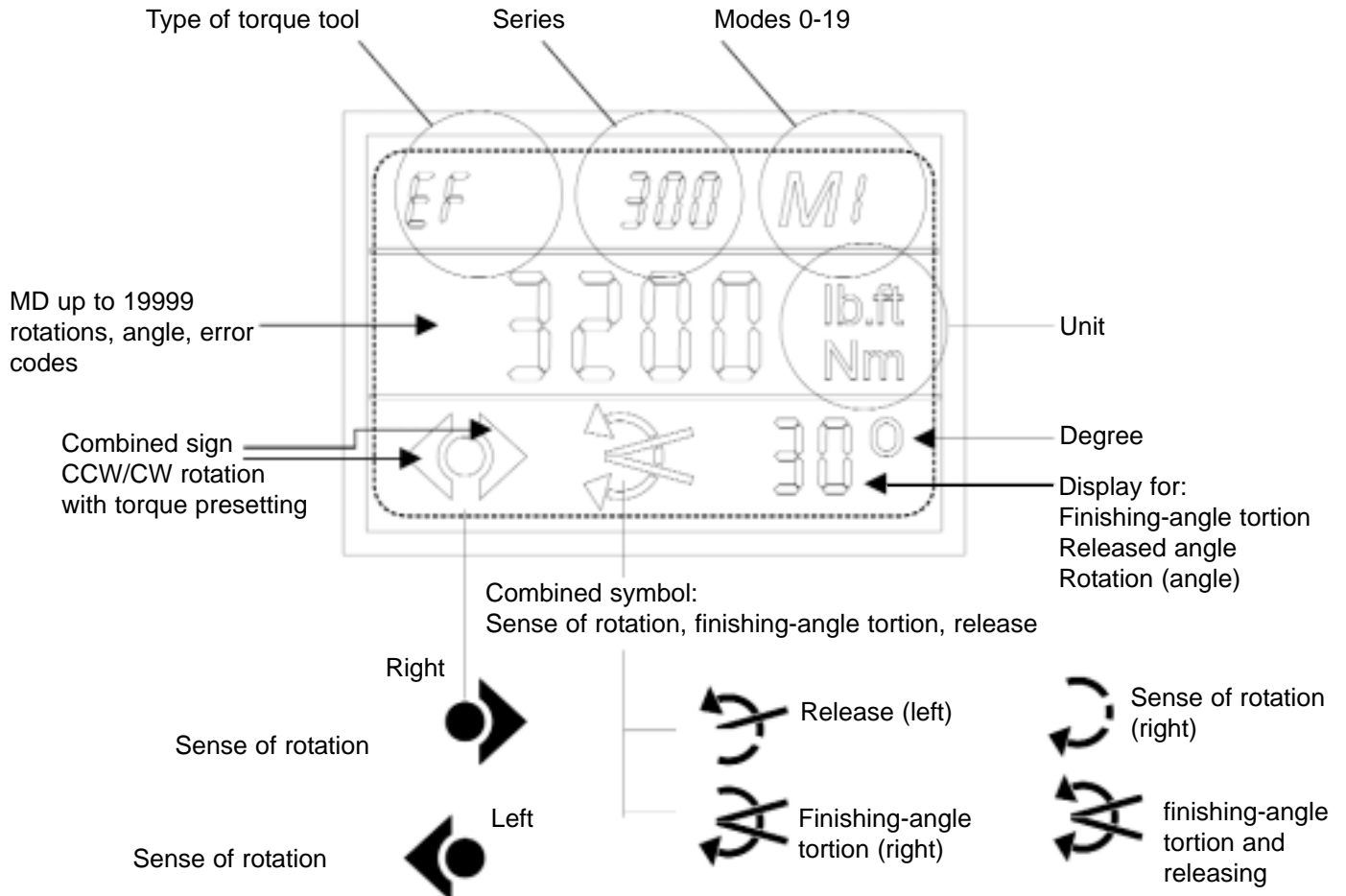

Electric Multipliers Operating Instructions

Rev 1.0

Mechanical Operation of Electric Multipliers

Two principles of construction within the tool.

- 1) Free joint tool/service unit independent of position of torque pick-up DMA (reaction device).
- 2) Fixed joint between motor/service unit and power gear - mechanically reversible (rigid condition).

Eliminator-EFW & Eliminator-EFW Plus



Reverseability swivelling/rigid
for Eliminator-EFW & Eliminator-EFW Plus

locking with
screwdriver

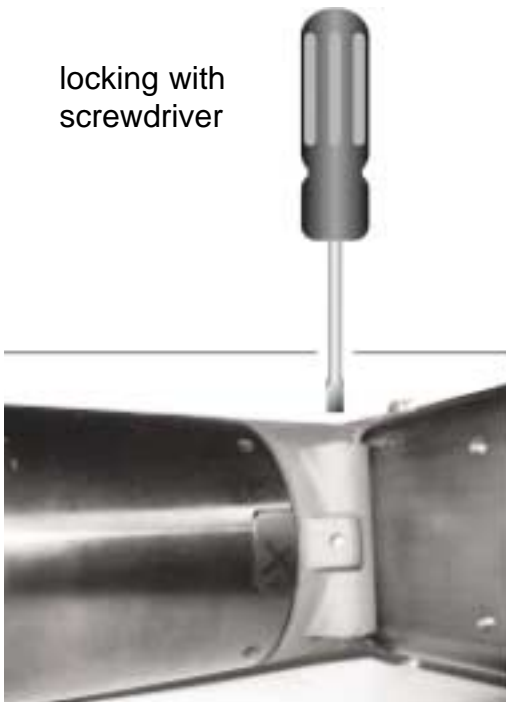

locking with thumbwheel screw

Electric Multipliers Operating Instructions

Rev 1.0

Tightening and Loosening



Be aware of rotating support arms or impact sockets. Keep clothing, hair, or any loose objects clear of moving parts. Always wear proper protective clothing such as glasses, ear protection and gloves during tool operation.

Do not leave the electric multiplier unattended while in operation. A safe distance of operation is approximately one arms length from the tool while in operation. Never place hand on reaction device (DMA) while in operation. Serious bodily injury can occur.

Always place standard socket or connector completely on screw or nut. Faulty screw connections may lead to materials overload. Moving parts may cause bruises or serious bodily injury.



Keep the electric multiplier in a vertical position (6) to the multiplier axis while fastening in order to avoid damage to socket and/or the application due to side loading (5).

Tightening and loosening screw connection procedures are as follows:

- Place the electric multiplier with a socket or connector completely on the screw or nut.
- Support arm of the electric multiplier must be placed on the same level as the socket or connector (4). Make sure a safe and stable counter mounting (5) is provided.
- Keep the electric multiplier in a vertical position while fastening.
- The motor will stop upon reaching the preset torque
 - a) Counter Force = Motor Force
 - b) Torque Reaction = Motor Force
 - c) The Pre-set torque has been reached
- Torque direction can now be changed - switch on tool shortly until reaction device is free - switch off motor. (This procedure is not necessary with the "Automatic function of the Eliminator-EF Plus or Eliminator-EFW Plus model).
- Remove tool, place it on the next screw or nut. Repeat fastening process.

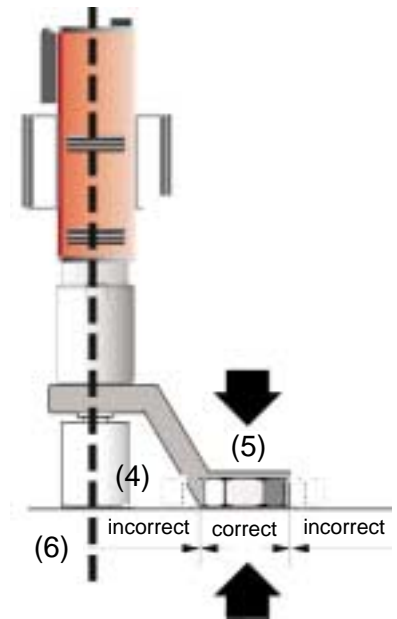

Electric Multipliers Operating Instructions

Rev 1.0

Eliminator-EFR

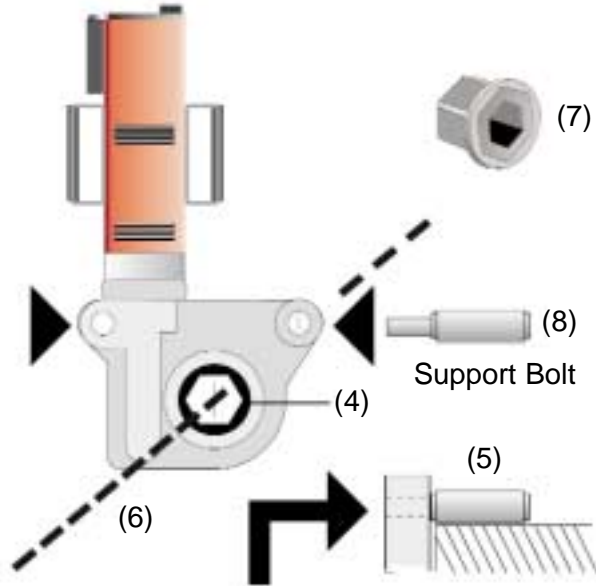

Insert the support bolt (8) completely in the housing hole of the Eliminator-EFR in order to avoid damage.

For tightening and loosening screw connections follow the instructions as stated before. On the radial drive of Eliminator-EFR the torque multiplier can be operated in a 90-degree angle due to the drive direction (6). The drive is carried out by a fixed socket size (4). The STA is used to reduce the socket size (7). Torque support is done by a support bolt (8). Make sure to have a safe and stable support (5). Also see drawing below.

Safe support is only achieved when the support bolt is completely inserted into the shells of the casing.

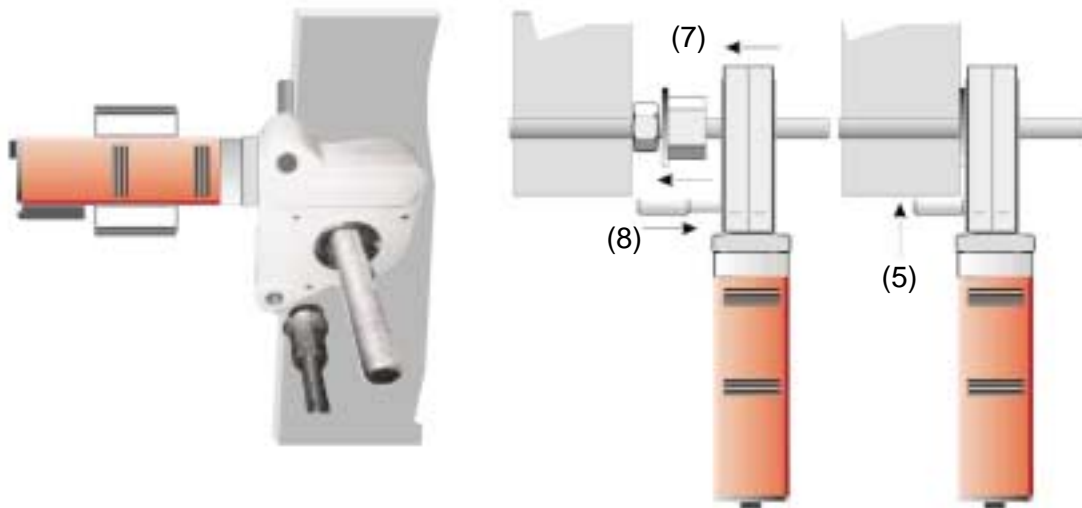

Finishing or interrupting operation (also with replacement)

- Always disconnect the tool from the power supply when not in use or while changing sockets and/or support.



Never carry the tool by the power cord. Always disconnect the cord by pulling at the plug. Protect cord from heat, oil and sharp edges to avoid accidental shock.

Electric Multipliers Operating Instructions

Rev 1.0

Noise and Vibration

Due to sound pressure level, it's recommended to use ear protection. The vibrations become moderate just prior to reaching the pre-set torque.

Service

Replacement of Standard socket / connector and reaction device (EF/EFW models)



Never use a tool that has been damaged. Use only manufacturer's parts.

- Disconnect power cord from power source
- Place the electric multiplier on a flat surface
- Remove rubber ring and safety pin/bolt - socket
- Reverse operation for replacement

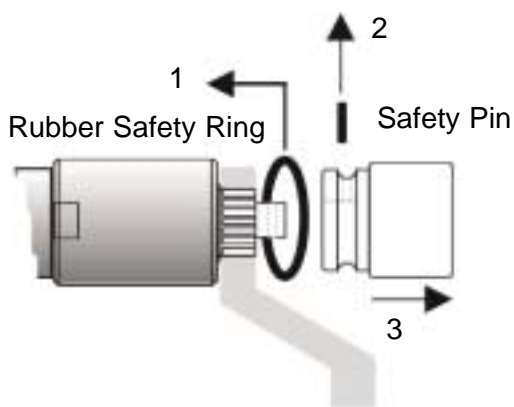
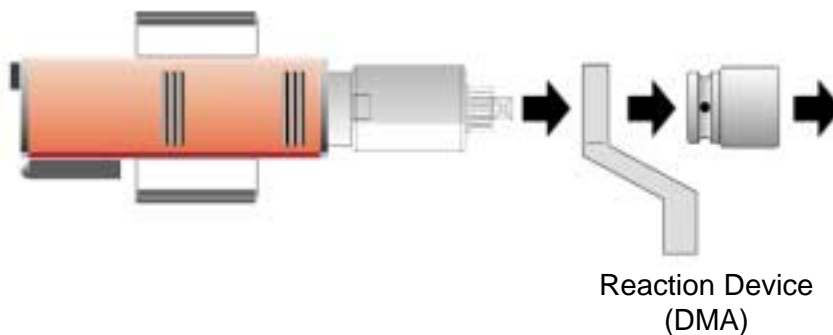

Standard Socket

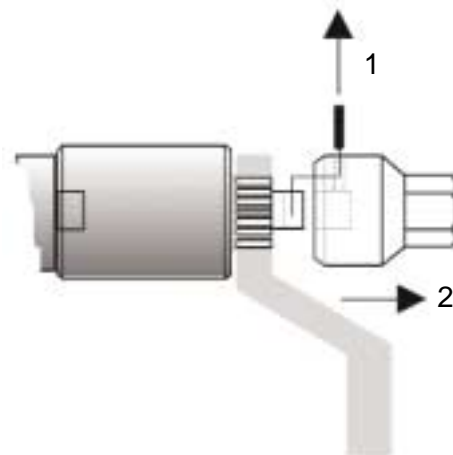

Standard Connector

Electric Multipliers Operating Instructions

Rev 1.0

Replacement for STA (Standard Adapter) and the Support Bolty for Eliminator-EFR

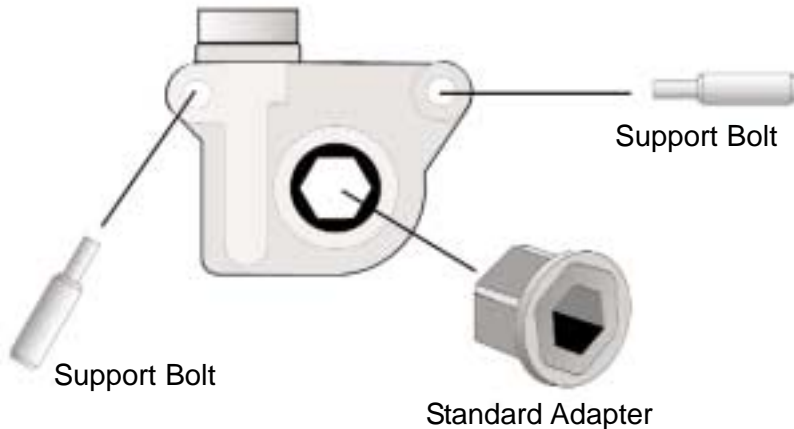

Properly insert support bolt and/or standard adapter to avoid damage.

Maintenance

Have the tool electric multiplier inspected regularly and maintained regularly (Power Check, Motor Check & Safety Check).

Have the tool inspected once a year or after a maximum of 1,000 operational hours.

Mountz Calibration & Repair Services

With over 39 years of experience, Mountz features an experienced calibration and repair staff that delivers rapid service and provides quality that you can trust. Mountz features a new state-of-the-art calibration lab and a repair facility. The Calibration Lab can calibrate up to 20,000 lbf.ft. Our certified technicians can calibrate & repair most any tool and our calibration standards are traceable to NIST (National Institute of Standards and Technology). Mountz factory service provides current upgrades for all digital torque analyzers at time of service.

Mountz Service Centers

Mountz, Inc.
19051 Underwood Rd
Foley, AL 36535
Phone: (251) 943-4125
Fax: (251) 943-4979

Mountz, Inc.
1080 N. 11th St
San Jose, CA 95112
Phone: (408) 292-2214
Fax: (251) 292-2733



mountz
the torque tool specialists

800-456-1828
Fax: 408-292-2214

mountzsales@mountztorque.com

www.eturque.com



ISO 9001